

KYN28-12

New type of armored removable
AC metal enclosed switchgear

KYN28A-12 (Z) (GZS1) armored movable AC metal enclosed switchgear (hereinafter referred to as "switchgear") is suitable for three-phase AC 50HZ power systems, used for contacting and distributing electrical energy, and controlling, protecting, and monitoring circuits.

This product complies with the following standards: GB3906 "3-35KV AC Metal Enclosed Switchgear" GBT11022 "Common Technical Requirements for High Voltage Switchgear and Control Equipment Standards", 1EC60298 "AC Metal Enclosed Switchgear and Control Equipment with Rated Voltage of 1kV and Above"



KYN28-12 新型铠装移开交流金属封闭开关设备

New armored removable
AC Metal -enclosed switchgear



○ 型号含义 Model meanings

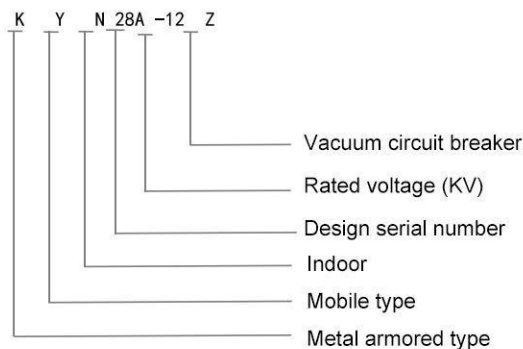

○ 使用条件 Working conditions

- ◆ Surrounding air temperature: maximum temperature +40 , minimum temperature -15 °C;
- ◆ Relative humidity: Daily average relative humidity: ≤ 95%, daily average water vapor pressure does not exceed 2.2KPa; Monthly average relative humidity ≤ 90%; The monthly average water vapor pressure does not exceed 1.8KPa; Altitude: ≤ 1000m;
- ◆ Earthquake intensity: not exceeding level 8;
- ◆ The surrounding air should not be significantly polluted by corrosive or combustible gases, water vapor, etc;
- ◆ No places with severe vibration;
- ◆ When using beyond the normal conditions specified in GB3906, the user and our company shall negotiate

○ 技术参数 Technical parameters

Project	Unit	Data	
Rated voltage	KV	3.6、7.2、12	
Rated frequency	Hz	50	
Rated current of circuit breaker	A	630、1250、1600、2000、2500、3150	
Rated current of switchgear	A	630、1250、1600、2000、2500、3150	
Rated short-term withstand current (4s)	KA	20、25、31.5、40	
Rated peak withstand current (peak)	KA	50、63、80、100	
Rated short-circuit breaking current	KA	20、25、31.5、40	
Rated short-circuit making current (peak)	KA	50、63、80、100	
Rated insulation level 1min power frequency withstand voltage	Between poles, between poles and ground	KV	24、32、42、
	Between fractures	KV	24、32、42、
Lightning impulse Withstand voltage (peak)	Between poles, between poles and ground	KV	40、60、75
	Between fractures	KV	46、70、85
Protection level		The shell is IP4X, and when the doors between compartments and circuit breakers are open, it is IP2X	

KYN28-12 新型铠装移开交流金属封闭开关设备

New armored removable
AC Metal -enclosed switchgear



VD4、VS1-12真空断路器技术参数 Parameters of vacuum circuit breaker

Project	Unit	Parameters
Rated voltage	KV	12
Rated frequency	Hz	50
Rated current of circuit breaker	A	630、1250、1600、2000、2500、3150
Rated dynamic stable current (4s)	A	16、20、25、31.5、40、50
Rated stable current (peak)	KA	40、50、63、80、100、125
Rated short-circuit breaking current	KA	16、20、25、31.5、40、50
Rated short-circuit making current (peak)	KA	40、50、63、80、100、125
Rated insulation level	1Min Power frequency withstand current	KV 42
	Lightning impulse withstand current	KV 75
Rated operating sequence		on-0.3S on/off -180s on/off 50
Rated short-circuit breaking current breaking frequency	Times	50
Machinical life	Times	20000

Project	Unit	Parameters
Contact opening distance	mm	11 ± 1
Overtravel	mm	4 ± 0.5
Middle distance between phases	mm	210 ± 0.5, 275 ± 0.5
Closing contact bounce time	ms	≤ 2
Three phase opening asynchrony	ms	≤ 2
Opening time when the operating electrical pressure is	Highest	ms ≤ 50
	Rated	ms ≤ 50
	Minimum	ms ≤ 60
Closing time	ms	≤ 100
Average closing speed	ms	0.9-1.2
Average opening speed	ms	0.6-0.8

When the circuit breaker is used to control the 3-10KV motor, if the starting current is less than 600A, a metal zinc oxide lightning arrester must be added. The specific requirements are negotiated between the user and our company: when the circuit breaker is used to disconnect the capacitor bank, the rated current of the capacitor should not exceed 80% of the rated current of the circuit breaker.

KYN28-12 新型铠装移开交流金属封闭开关设备

New armored removable
AC Metal -enclosed switchgear



○ 操作机构技术参数 Technical parameters of operating mechanism

Project		Unit	Parameters
Rated operating voltage	Closing coil	V	AC/DC220, 110
	Opening coil	V	AC/DC220, 110
Coil power	Closing coil	W	245
	Opening coil	W	245
Energy storage motor power		W	50
Rated voltage of energy storage motor		V	AC/DC220, 110
Energy storage time		S	≤10

The switchgear is designed according to the armored metal enclosed switchgear in GB3906-91. The whole is composed of two main parts: a cabinet and a central withdrawable spare part (i.e. a handcart) (see Figure 1). The cabinet is divided into four separate compartments, with an enclosure protection level of IP4X. When the doors of each compartment and circuit breaker room are opened, the protection level is IP2X. Equipped with overhead incoming and outgoing lines, cable incoming and outgoing lines, and other functional schemes, arranged and combined to form a complete set of power distribution system devices. This switchgear can be installed, debugged, and maintained from the front, so it can be back-to-back, arranged in a double arrangement, and installed against the wall, improving the safety, flexibility, and reducing the footprint of the switchgear.

◆ Shell and others

The main frame of the switchgear is made of aluminum zinc thin steel plate, processed by CNC machine tool, and adopts multiple folding process, which not only has the advantages of high precision, strong corrosion resistance and oxidation resistance, but also makes the cabinet lighter in weight, higher in mechanical strength, and more aesthetically pleasing in appearance compared to other similar equipment cabinets due to the use of multiple folding process. The cabinet adopts an assembled structure, connected by rivet nuts and high-strength bolts, which shortens the processing cycle, enhances the universality of components, occupies less space, and is convenient for organizing production.

◆ Handcart

The handcart frame is assembled from thin steel plates processed by CNC machine tools. The handcart and cabinet are insulated and coordinated, and the interlocking mechanism is safe, reliable, and flexible. According to their usage, handcart can be divided into circuit breaker handcart, voltage transformer handcart, metering handcart, isolation handcart, and other types of handcart. According to module and block type variations, handcart of the same specification can be freely exchanged 100%. The handcart has a disconnection position, a testing position, and a working position inside the cabinet. Each position is equipped with a positioning device to ensure reliable interlocking. The operation must be carried out according to the interlocking protection measures operation procedure. All handcart uses nuts and screws to move and exit, and its operation is light and flexible, suitable for on duty personnel to operate. When the handcart needs to be moved away from the cabinet, a dedicated transfer vehicle can be easily pulled out for various inspections and maintenance, And it adopts a mid mounted design, with a small volume for inspection, maintenance, and convenience.

◆ Compartment

The main electrical components of the switchgear have independent compartments, namely: circuit breaker handcart room, busbar room, cable room, relay instrument room. The protection level between each compartment reaches IP2x; Except for the relay, all other three formats have their own pressure relief channels. Due to the use of a central layout, the cable room space is greatly increased, allowing the equipment to connect multiple cables.

◆ Circuit breaker compartment

Tracks are installed on both sides of the compartment for handcart 5 to move and slide from the disconnected position and test position to the working position inside the cabinet. The partition 3 (valve) of the static contact box 16 is installed behind the rear wall of the handcart compartment. When the handcart moves from the disconnected position test position to the working position, the flaps on the upper and lower static contact boxes are linked with the handcart and automatically open. When moving in the opposite direction, the flaps automatically close until the handcart returns to a certain position and completely covers the static contact box, forming effective isolation. Due to the separate operation of the upper and lower valves, during maintenance, the valve on the live side can be locked to ensure that maintenance personnel do not touch the live body. When the circuit breaker room door is closed, the handcart can also be operated. Through the observation window of the middle door, the position of the handcart being disposed of and closed in the compartment can be observed, and the energy storage status can be displayed.

◆ Bus compartment

The main busbar 18 is a single unit spliced and connected to each other, fixed by the main busbar 20 and the static contact box. The main busbar and connecting busbar are copper bars with rectangular cross-sections, used for high currents. When composite, double busbars are used to assemble them. The branch busbar is connected to the static contact box 16 and the main busbar through bolts and does not require any other support. For special needs, the busbar can be covered with heat shrink tubing, insulation sleeves with connecting bolts, and end caps. Adjacent cabinet busbars are fixed with sleeve 19, so that the air buffer retained between the connecting busbars can prevent melting in the event of internal fault arcs. Sleeve 19 can effectively limit accidents to this cabinet and not spread to other cabinets.

KYN28-12 新型铠装移开交流金属封闭开关设备

New armored removable
AC Metal -enclosed switchgear



结构特点 Structural characteristics

- ◆ The following diagram shows the structural components of the switchgear. All metal modular assembly structure, the cabinet body is made of imported aluminum zinc coated plate with strong anti-corrosion ability, without surface treatment. It is processed by CNC high-precision equipment and adopts advanced multiple folding process. The connection is connected with rivet nuts and high-strength bolts, with high accuracy, light weight, and good strength.
- ◆ The switchgear can be equipped with our company's VS1 series, VD4 series, ZN65 series and other vacuum circuit breakers, with wide applicability and strong interchangeability. The handcart is equipped with a working position, a testing position, and positioning and display devices at each position, ensuring safety and reliability.
- ◆ The cable room can accommodate up to 9 single core cables, and the equipment is equipped with reliable mechanical and electrical interlocking devices, fully meeting the "five prevention" requirements. Each room is equipped with pressure relief channels to ensure personal safety during operation.

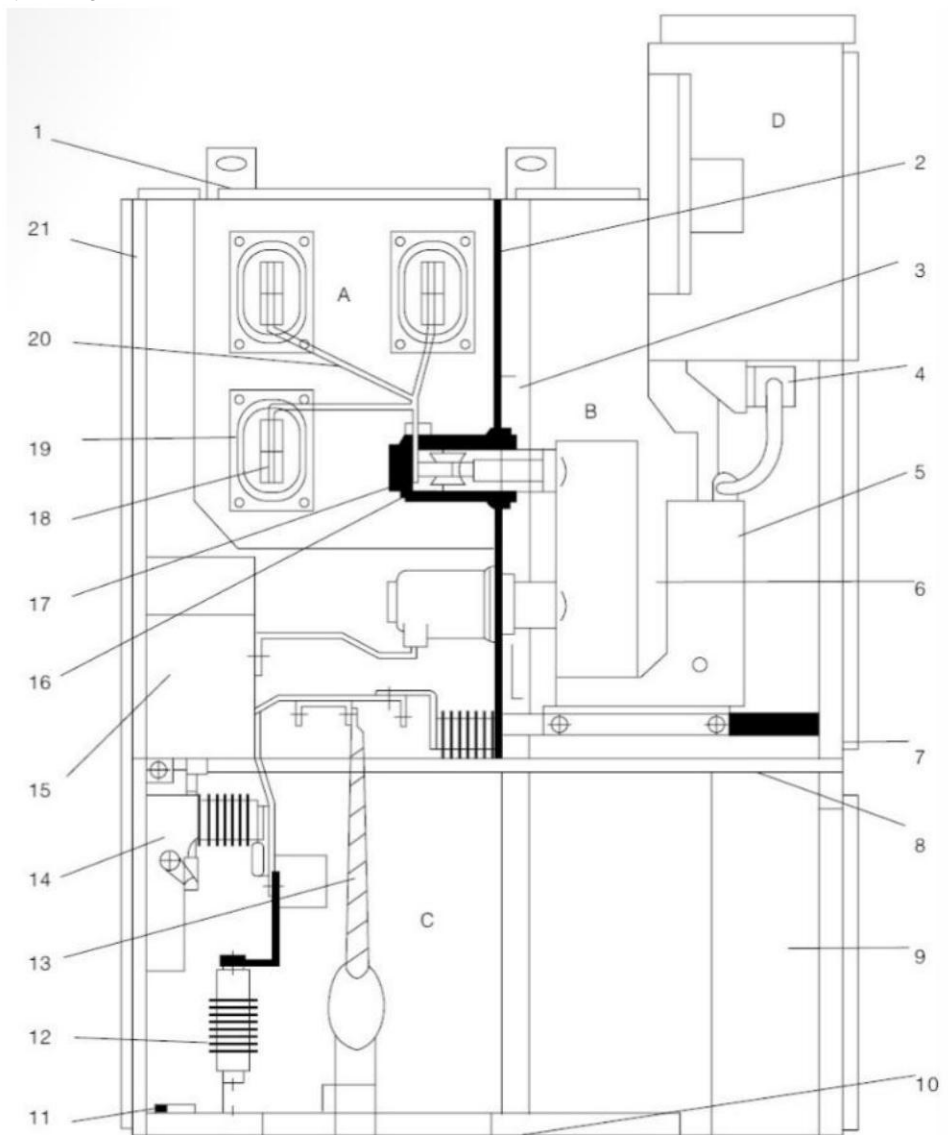

KYN28-12 新型铠装移开交流金属封闭开关设备

New armored removable
AC Metal -enclosed switchgear



外形尺寸 Overall dimensions

Hight			2300
Width	Rated current	Rated current 1250A and above	800
	1250A and below	Rated current 1600A and above	1000
Depth	Cable inlet and outlet lines	Cable inlet and outlet lines	1500
	Aerial incoming and outgoing lines	Aerial incoming and outgoing lines	1600

安装尺寸 (mm) Installation size

Cabinet width A	Cabinet depth B	L1	L2	L3	L4
800	1500 Cable	530	630	150	490
	1660 Aerial	530	630	310	650
1000	1500 Cable	730	830	150	490
	1660 Aerial	730	830	310	650

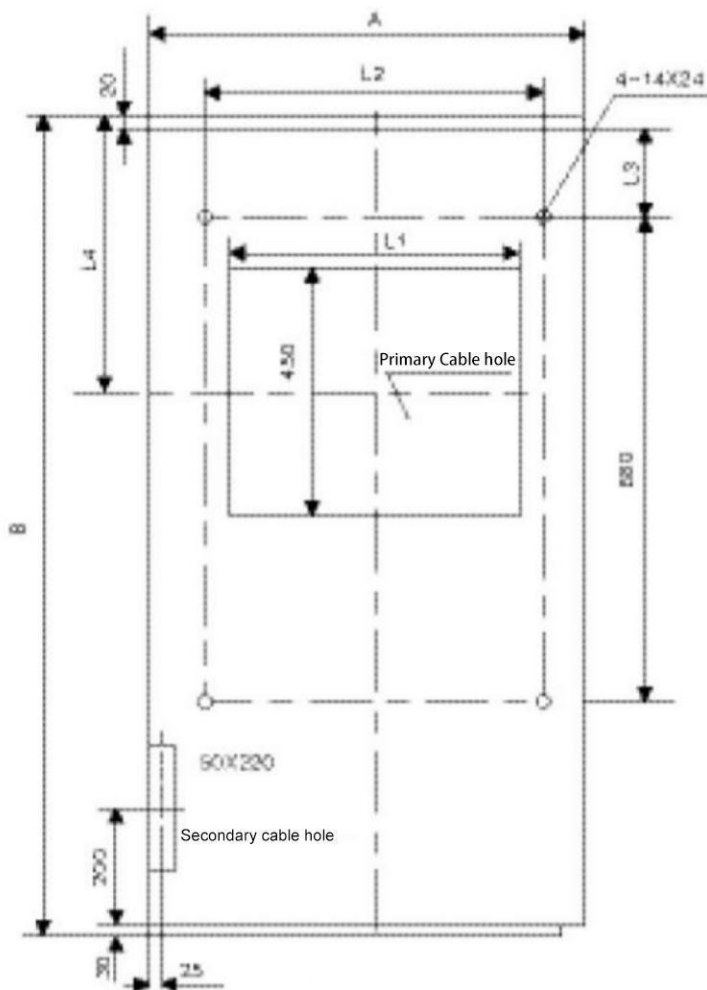



The back of the cabinet

KYN28-12 新型铠装移开交流金属封闭开关设备

New armored removable
AC Metal -enclosed switchgear

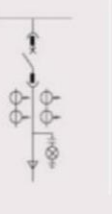
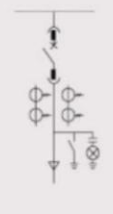
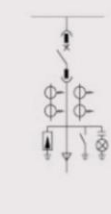
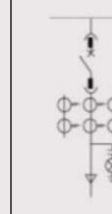
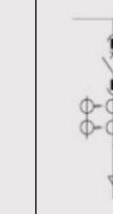
○ 外形尺寸 Overall dimension

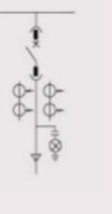
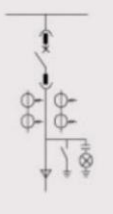
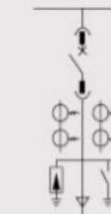
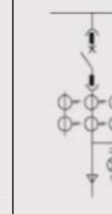
Plan number		1	4	15	16	17	18
Main circuit scheme diagram							
Cabinet size (width * depth * height) mm		800 (1000) *1660*2300					
Rated current		630~3150					
Main electrical components	Vacuum circuit breaker (VS1 or Vd4)	1		1	1	1	1
	Current Transformer LZZBJ9 Series	2		2	2	3	3
	Grounding switch			1	1		1
					3		3
Circuit name		Receiving electricity,feed					
Remarks		1. Rated current 1600A and above, cabinet width 1000mm. 2. The prototype switchgear with an altitude of 3000m~4000m has a rated current of 1250A and a cabinet width of 1000m					

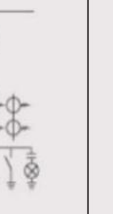
Plan number		13	1	4	15	16	17	18
Main circuit scheme diagram								
Cabinet size (width * depth * height) mm		800 (1000) *1660*2300						
Rated current		630~3150						
Main electrical components	Vacuum circuit breaker (VS1 or Vd4)	1	1		1	1	1	1
	Current Transformer LZZBJ9 Series	2	2		2	2	3	3
	Grounding switch		1			1		1
Circuit name		Connection (right)	Connection (right)		Connection (left)	Connection (left)	Connection (right)	Connection (right)
Remarks		Rated current 1600A and above, cabinet width 1000mm						

KYN28-12 新型铠装移开交流金属封闭开关设备

New armored removable
AC Metal -enclosed switchgear



○ 外形尺寸 Overall dimension

Plan number		01	02	02	17	18	
Main circuit scheme diagram							
Cabinet size (width * depth * height) mm		800 (1000) *1660*2300					
Rated current		630~3150					
Main electrical components	Vacuum circuit breaker (VS1 or Vd4)	1	1	1	1	1	1
	Current Transformer LZZBJ9 Series	3	3	2	3	2	2
	Grounding switch JN15		1		1		1
Circuit name		Connection (left)	Connection (left)	Aerial incoming line (left connection)	Aerial incoming line (left connection)	Aerial incoming line (right connection)	Aerial incoming line (right connection)
Remarks		Rated current 1600A and above, cabinet width 1000mm					

Plan number		13	1 4	15	16	17	18
Main circuit scheme diagram							
Cabinet size (width * depth * height) mm		800 (1000) *1660*2300					
Rated current		630~3150					
Main electrical components	Vacuum circuit breaker (VS1 or Vd4)	1	1	1	1	1	1
	Current Transformer LZZBJ9 Series	3	3	3	3	2	2
	Grounding switch JN15		1		1		1
Circuit name		Aerial incoming line (left connection)	Aerial incoming line (left connection)	Aerial incoming line (right connection)	Aerial incoming line (right connection)	Aerial incoming and outgoing lines	Aerial incoming and outgoing lines
Remarks		Rated current 1600A and above, cabinet width 1000mm					